

DATA SHEET

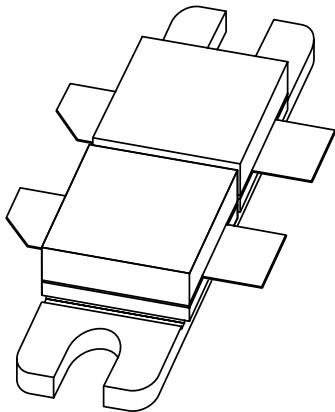

BLV862

**UHF linear push-pull power
transistor**

Product specification
Supersedes data of 1997 Oct 14

1999 Jun 25

UHF linear push-pull power transistor

BLV862

FEATURES

- Double stage internal input and output matching networks for an optimum wideband capability and high gain
- Polysilicon emitter ballasting resistors for an optimum temperature profile
- Gold metallization ensures excellent reliability.

APPLICATIONS

- Common emitter class-AB operation in output stages in bands 4 and 5 (470 to 860 MHz) television transmitter amplifiers (vision or sound).

DESCRIPTION

NPN silicon planar epitaxial transistor with two sections in push-pull configuration. The device is encapsulated in a SOT262B 4-lead rectangular flange package, with two ceramic caps.

PINNING

PIN	SYMBOL	DESCRIPTION
1	c1	collector 1; note 1
2	c2	collector 2; note 1
3	b1	base 1
4	b2	base 2
5	e	common emitter; note 2

Notes

1. Collectors 1 and 2 are connected together internally.
2. Common emitters are connected to the flange.

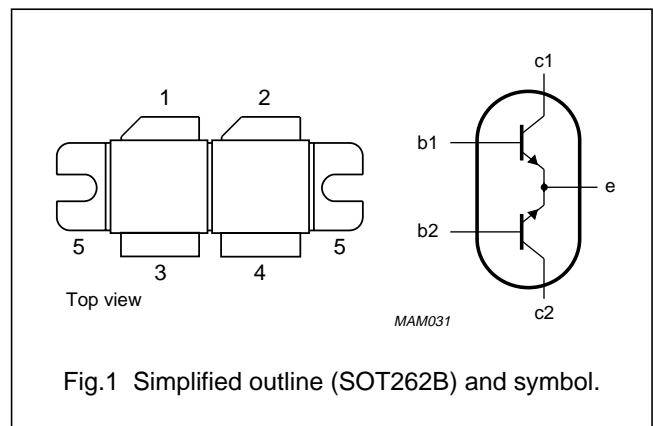

QUICK REFERENCE DATA

RF performance at $T_h = 25\text{ }^\circ\text{C}$ in a common emitter push-pull test circuit.

MODE OF OPERATION	f (MHz)	V_{CE} (V)	P_L (W)	G_p (dB)	η_c (%)	ΔG_p (dB)
CW class-AB	860	28	150	≥ 8 typ. 9	≥ 45 typ. 52	≤ 1

WARNING

Product and environmental safety - toxic materials

This product contains beryllium oxide. The product is entirely safe provided that the BeO discs are not damaged. All persons who handle, use or dispose of this product should be aware of its nature and of the necessary safety precautions. After use, dispose of as chemical or special waste according to the regulations applying at the location of the user. It must never be thrown out with the general or domestic waste.

UHF linear push-pull power transistor

BLV862

LIMITING VALUES

In accordance with the Absolute Maximum Rating System (IEC 134).

SYMBOL	PARAMETER	CONDITIONS	MIN.	MAX.	UNIT
V_{CBO}	collector-base voltage	open emitter	–	65	V
V_{CEO}	collector-emitter voltage	open base	–	30	V
V_{EBO}	emitter-base voltage	open collector	–	3	V
I_C	collector current (DC)		–	25	A
P_{tot}	total power dissipation	$T_{mb} = 25\text{ °C}$	–	350	W
T_{stg}	storage temperature		–65	+150	°C
T_j	operating junction temperature		–	200	°C

THERMAL CHARACTERISTICS

SYMBOL	PARAMETER	CONDITIONS	VALUE	UNIT
$R_{th\ j-mb}$	thermal resistance from junction to mounting base	$P_{tot} = 350\text{ W}$; note 1	0.5	K/W
$R_{th\ mb-h}$	thermal resistance from mounting base to heatsink	note 1	0.15	K/W

Note

1. Thermal resistance is determined under specified RF operating conditions.

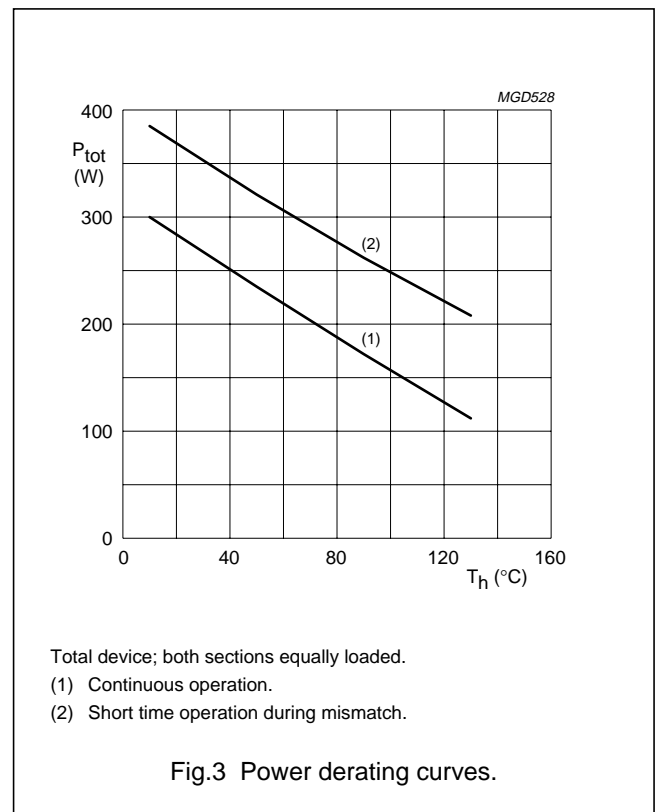
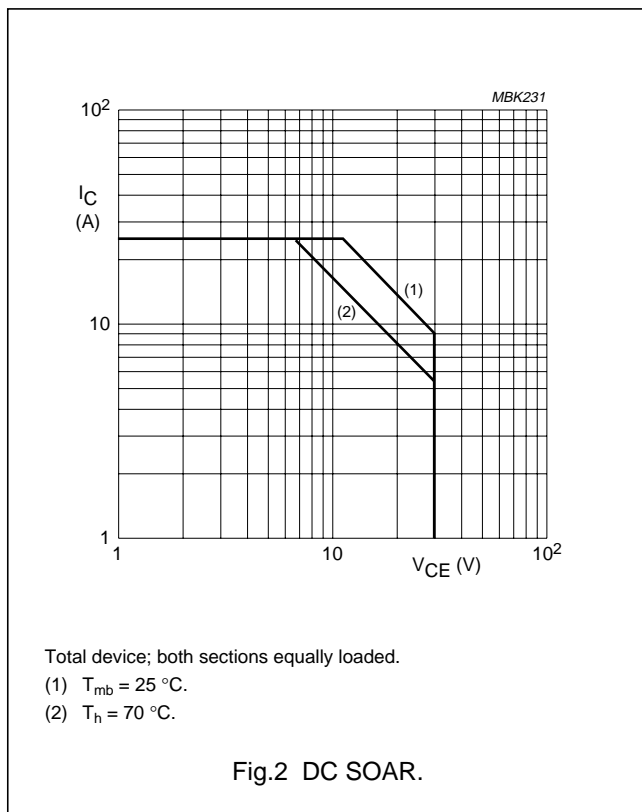

UHF linear push-pull power transistor

BLV862

CHARACTERISTICSValues apply to either transistor section; $T_j = 25\text{ °C}$ unless otherwise specified.

SYMBOL	PARAMETER	CONDITIONS	MIN.	TYP.	MAX.	UNIT
$V_{(BR)CBO}$	collector-base breakdown voltage	$I_E = 0; I_C = 60\text{ mA}$	65	–	–	V
$V_{(BR)CEO}$	collector-emitter breakdown voltage	$I_B = 0; I_C = 150\text{ mA}$	30	–	–	V
$V_{(BR)EBO}$	emitter-base breakdown voltage	$I_E = 3\text{ mA}; I_C = 0$	3	–	–	V
I_{CBO}	collector-base leakage current	$V_{CB} = 28\text{ V}$	–	–	5	mA
h_{FE}	DC current gain	$I_C = 4.5\text{ A}; V_{CE} = 10\text{ V}$	30	–	140	–
Δh_{FE}	DC current gain ratio of both sections	$I_C = 4.5\text{ A}; V_{CE} = 10\text{ V}$	0.67	–	1.5	–
C_c	collector capacitance	$I_E = i_e = 0; V_{CE} = 28\text{ V};$ $f = 1\text{ MHz};$ note 1	–	75	–	pF

Note

- The value of C_c is that of the die only, it is not measurable because of the internal matching network.

APPLICATION INFORMATIONRF performance at $T_h = 25\text{ °C}$ in a common emitter push-pull class-AB test circuit; note 1.

MODE OF OPERATION	f (MHz)	V_{CE} (V)	I_{CQ} (A)	P_L (W)	G_p (dB)	η_c (%)	ΔG_p (dB)
CW class-AB	860	28	0.8	150	≥ 8 typ. 9	≥ 45 typ. 52	≤ 1

Note

- See application note "AN98014 in handbook SC19b."

Ruggedness in class-AB operation

The BLV862 is capable of withstanding a load mismatch corresponding to $VSWR = 2 : 1$ through all phases under the conditions: $T_h = 25\text{ °C}$; $f = 860\text{ MHz}$; $V_{CE} = 28\text{ V}$; $I_{CQ} = 0.8\text{ A}$; $P_L = 150\text{ W}$; $R_{th\text{ mb-h}} = 0.15\text{ K/W}$.

UHF linear push-pull power transistor

BLV862

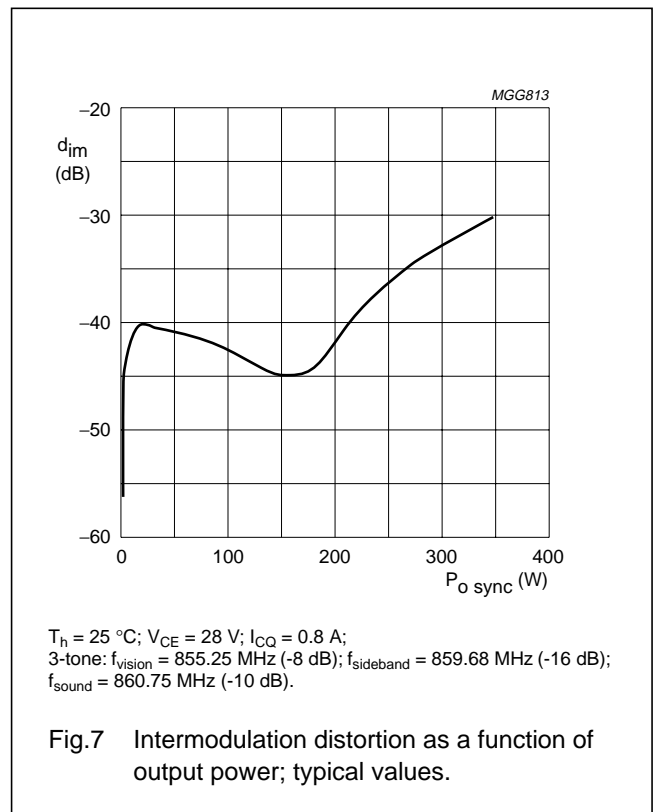
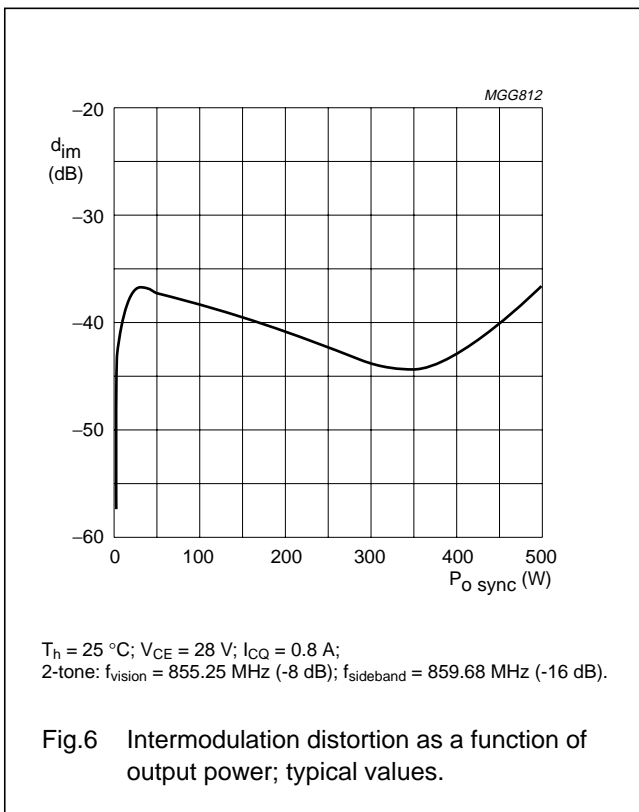
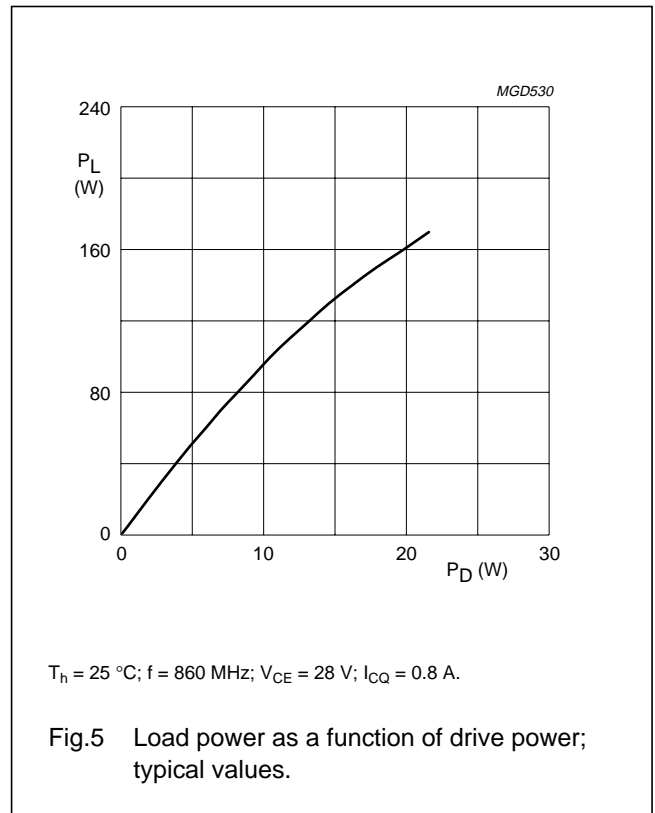
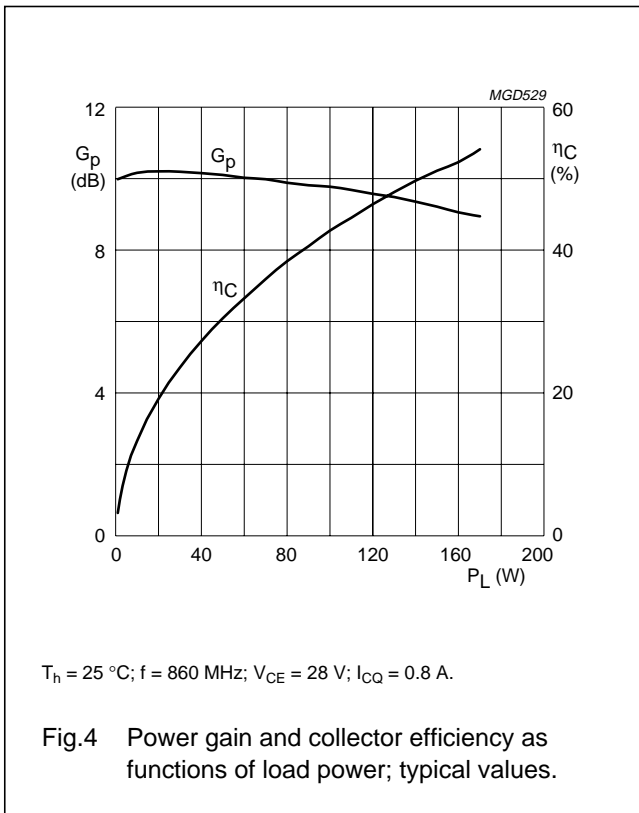

UHF linear push-pull power transistor

BLV862

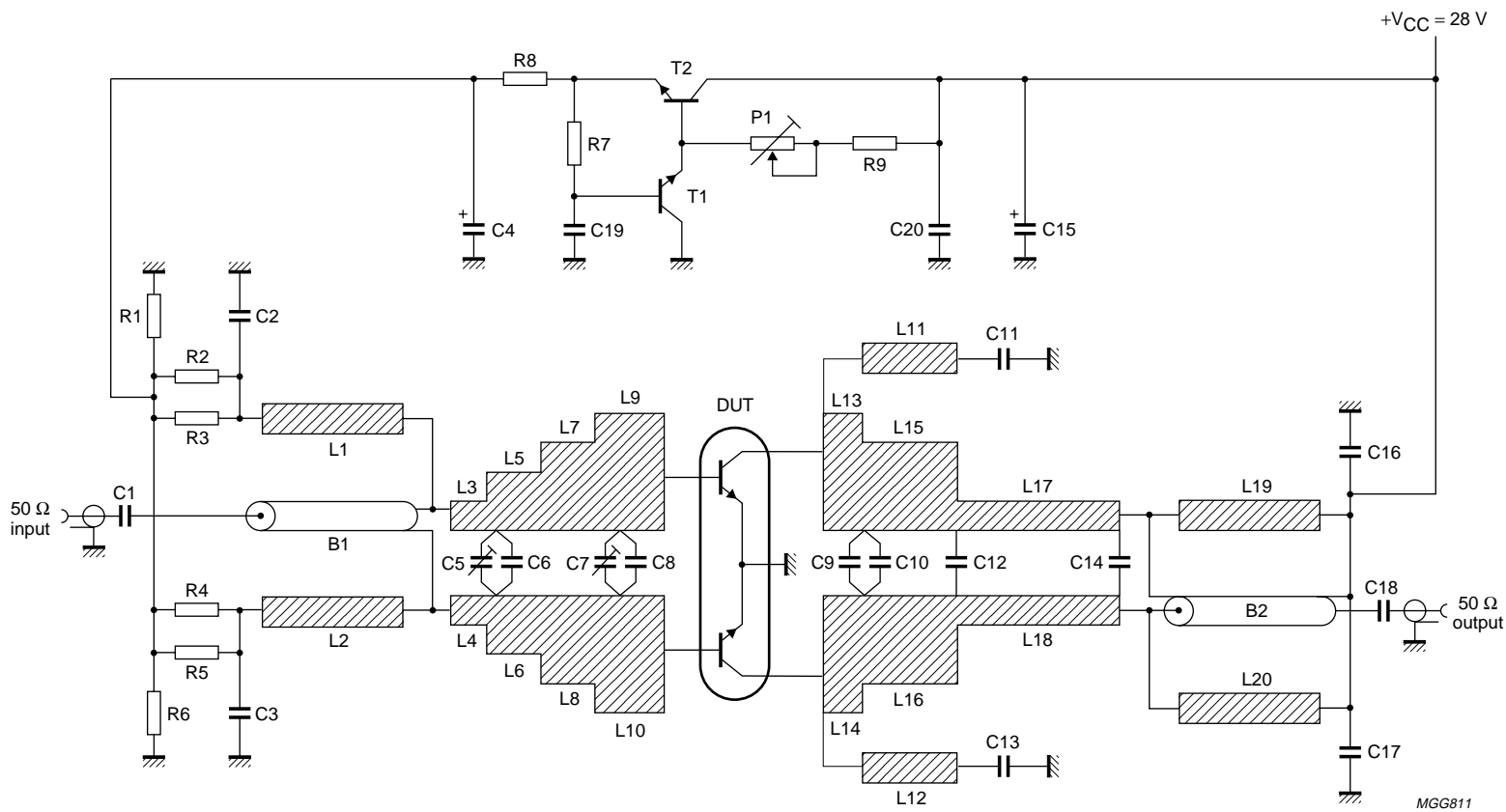
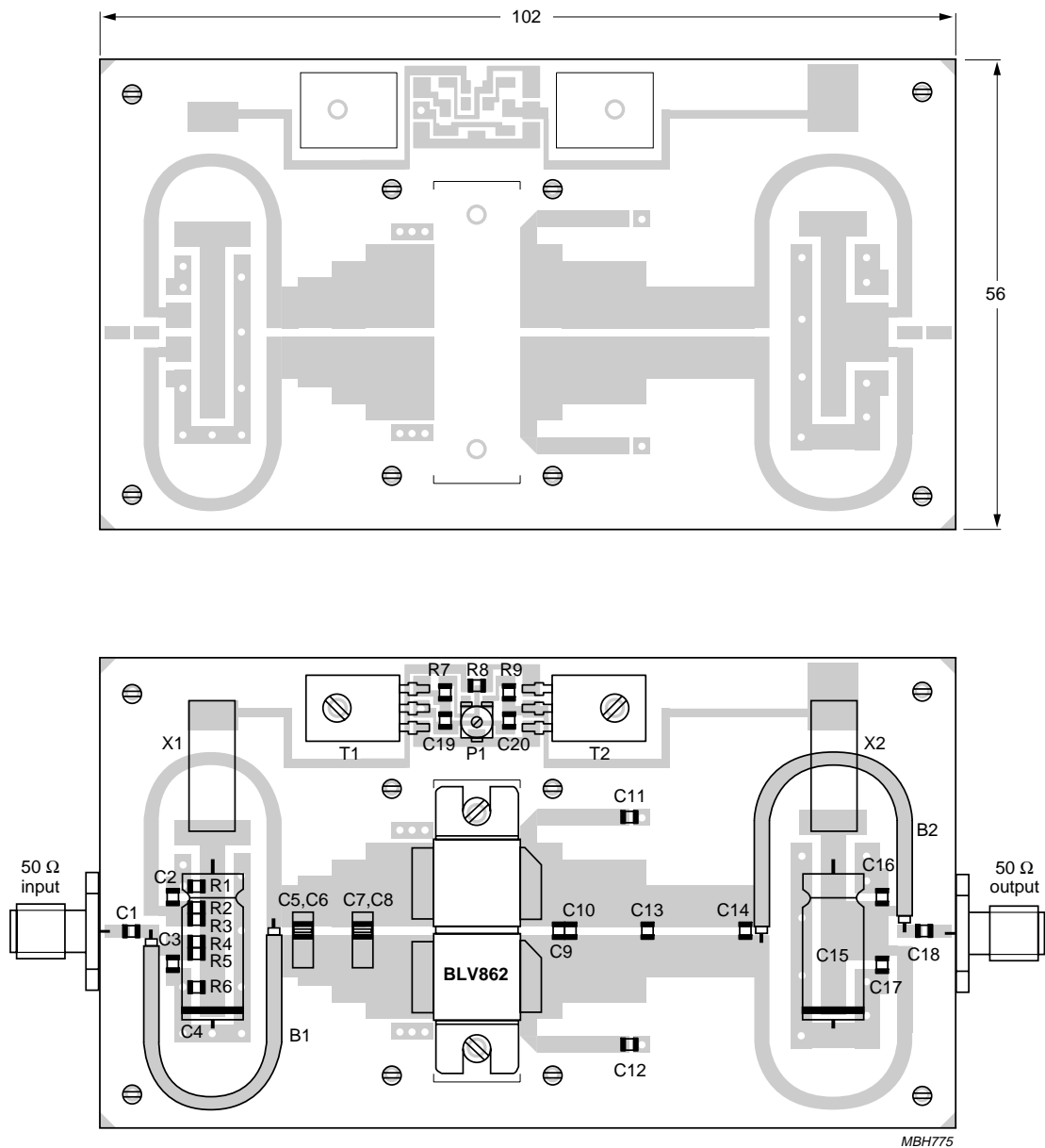

Fig.8 Class-AB test circuit at $f = 860$ MHz.

UHF linear push-pull power transistor

BLV862



Dimensions in mm.

The components are situated on one side of the copper-clad PTFE-glass board (TLX8) from Taconic, the other side is unetched and serves as a ground plane. Earth connections from the component side to the ground plane are made by through metallization.

Fig.9 Printed-circuit board and component lay-out for the 860 MHz class-AB test circuit.

UHF linear push-pull power transistor

BLV862

List of components

COMPONENT	DESCRIPTION	VALUE	DIMENSIONS	CATALOGUE No.
C1	multilayer ceramic chip capacitor; note 1	10 pF		
C2, C3	multilayer ceramic chip capacitor	1 nF		2222 852 47102
C4	solid aluminium capacitor	220 μ F; 16 V		2222 031 35221
C5, C7	Tekelec trimmer	1 to 5 pF		
C6, C8	multilayer ceramic chip capacitor; note 2	6.8 pF		
C9, C10	multilayer ceramic chip capacitor; note 3	10 pF		
C11, C13	multilayer ceramic chip capacitor; note 1	100 pF		
C12	multilayer ceramic chip capacitor; note 1	8.2 pF		
C14	multilayer ceramic chip capacitor; note 2	3.9 pF		
C15	solid aluminium capacitor	100 μ F; 40 V		2222 031 37101
C16, C17	multilayer ceramic chip capacitor	100 nF		2222 852 47104
C18	multilayer ceramic chip capacitor; note 1	22 pF		
C19	multilayer ceramic chip capacitor; note 1	100 pF		
C20	multilayer ceramic chip capacitor	15 nF		2222 852 47153
L1, L2	stripline; note 4		47 \times 1.8 mm	
L3, L4	stripline; note 4		2 \times 5 mm	
L5, L6	stripline; note 4		4 \times 6 mm	
L7, L8	stripline; note 4		4 \times 8 mm	
L9, L10	stripline; note 4		8.1 \times 10 mm	
L11, L12	stripline; note 4		15 \times 2 mm	
L13, L14	stripline; note 4		5 \times 10 mm	
L15, L16	stripline; note 4		10 \times 8 mm	
L17, L18	stripline; note 4		12.9 \times 5 mm	
L19, L20	stripline; note 4		48.7 \times 1.8 mm	
B1	semi rigid coax balun UT70-25	$Z = 25 \Omega \pm 1.5 \Omega$	47 mm	
B2	semi rigid coax balun UT70-25	$Z = 25 \Omega \pm 1.5 \Omega$	48.7 mm	
R1, R6	SMD resistor	100 Ω	0805	2122 118 03881
R2, R3, R4, R5, R8	SMD resistor	1 Ω	0805	2122 118 04562
R7	SMD resistor	47 Ω	0805	2122 118 04598
R9	SMD resistor	1.2 k Ω	0805	2122 118 04579
P1	potentiometer	4.7 k Ω		
X1, X2	copper ribbon hairpin			
T1, T2	NPN transistor	BD139		9330 912 20112

Notes

1. American Technical Ceramics type 100A or capacitor of same quality.
2. American Technical Ceramics type 100B or capacitor of same quality.
3. American Technical Ceramics type 180R or capacitor of same quality.
4. The striplines are on a double copper-clad printed-circuit board: PTFE-glass material (TLX8) from Taconic ($\epsilon_r = 2.55$); thickness 0.5 mm.

UHF linear push-pull power transistor

BLV862

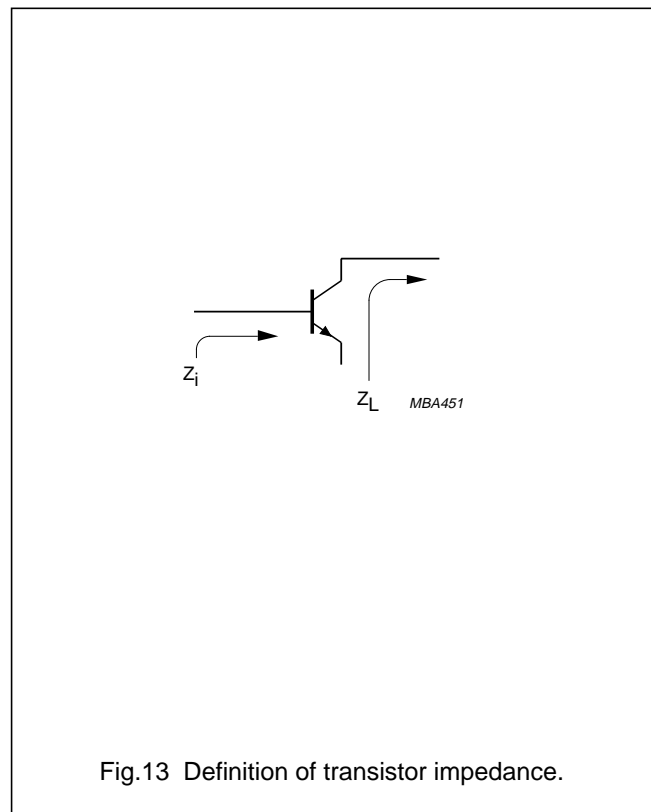
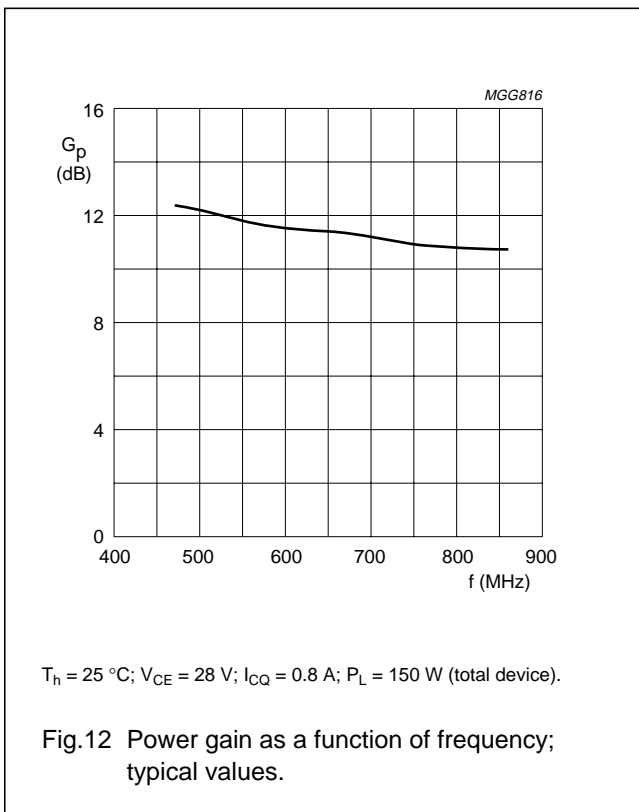
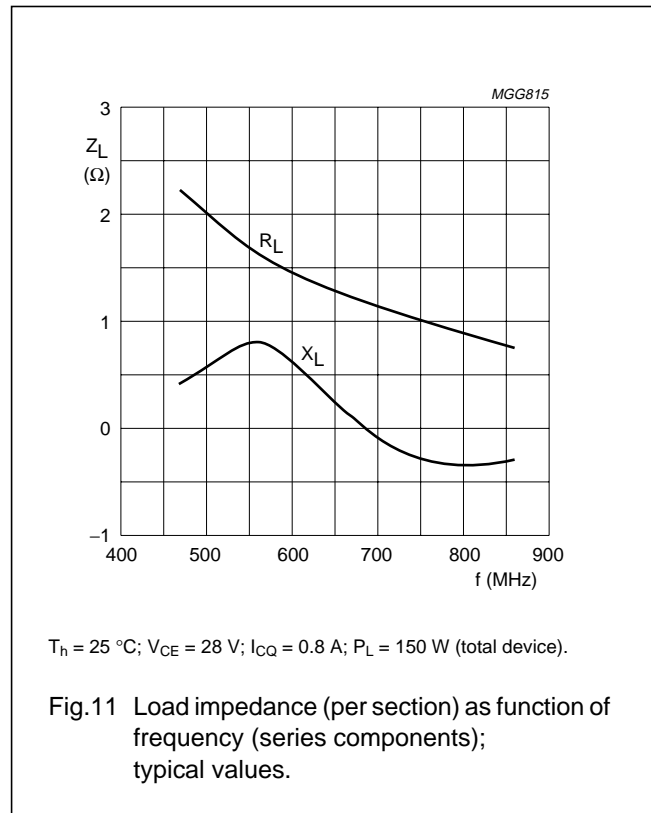
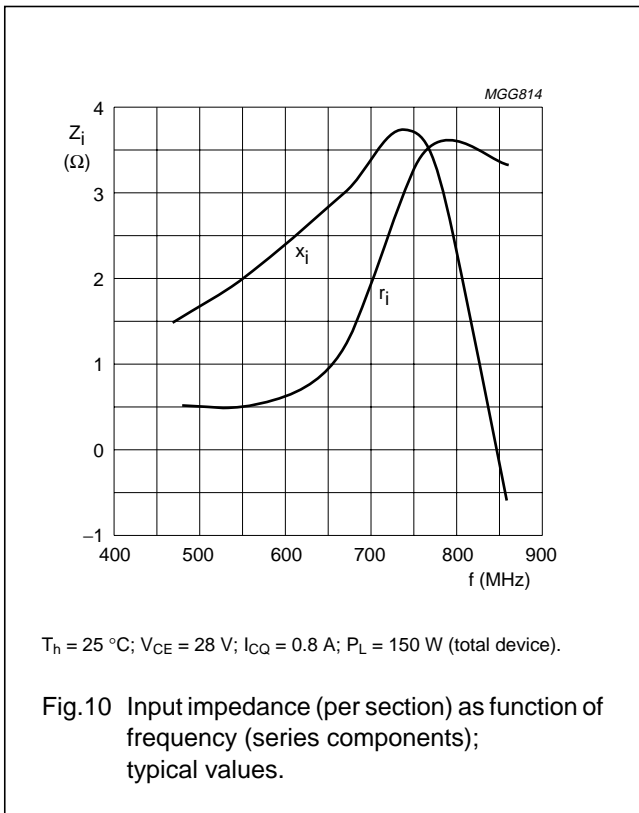

UHF linear push-pull power transistor

BLV862

PACKAGE OUTLINE

Flanged double-ended ceramic package; 2 mounting holes; 4 leads

SOT262B

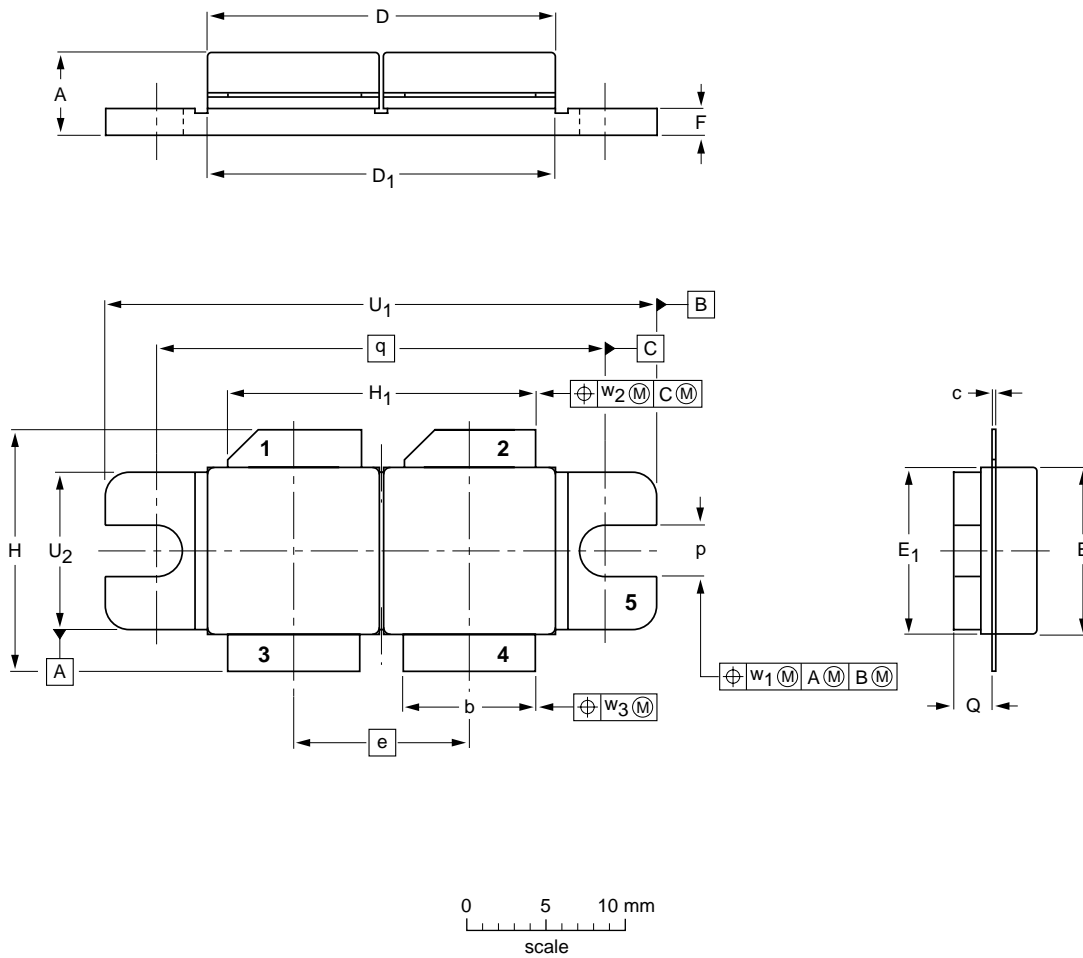

DIMENSIONS (millimetre dimensions are derived from the original inch dimensions)

UNIT	A	b	c	D	D ₁	e	E	E ₁	F	H	H ₁	p	Q	q	U ₁	U ₂	w ₁	w ₂	w ₃
mm	5.39 4.62	8.51 8.25	0.16 0.10	22.17 21.46	21.98 21.71	11.05	10.27 10.05	10.29 10.03	1.78 1.52	15.49 14.99	19.69 19.17	3.28 3.02	2.47 2.20	27.94	34.17 33.90	9.91 9.65	0.25	0.51	0.25
inches	0.212 0.182	0.335 0.325	0.006 0.004	0.873 0.845	0.865 0.855	0.435	0.404 0.396	0.405 0.396	0.070 0.060	0.61 0.59	0.775 0.755	0.129 0.119	0.097 0.087	1.100	1.345 1.335	0.390 0.380	0.010	0.020	0.010

OUTLINE VERSION	REFERENCES			EUROPEAN PROJECTION	ISSUE DATE
	IEC	JEDEC	EIAJ		
SOT262B					99-03-29

UHF linear push-pull power transistor

BLV862

DEFINITIONS

Data Sheet Status	
Objective specification	This data sheet contains target or goal specifications for product development.
Preliminary specification	This data sheet contains preliminary data; supplementary data may be published later.
Product specification	This data sheet contains final product specifications.
Limiting values	
Limiting values given are in accordance with the Absolute Maximum Rating System (IEC 134). Stress above one or more of the limiting values may cause permanent damage to the device. These are stress ratings only and operation of the device at these or at any other conditions above those given in the Characteristics sections of the specification is not implied. Exposure to limiting values for extended periods may affect device reliability.	
Application information	
Where application information is given, it is advisory and does not form part of the specification.	

LIFE SUPPORT APPLICATIONS

These products are not designed for use in life support appliances, devices, or systems where malfunction of these products can reasonably be expected to result in personal injury. Philips customers using or selling these products for use in such applications do so at their own risk and agree to fully indemnify Philips for any damages resulting from such improper use or sale.

Philips Semiconductors – a worldwide company

Argentina: see South America

Australia: 34 Waterloo Road, NORTH RYDE, NSW 2113,
Tel. +61 2 9805 4455, Fax. +61 2 9805 4466

Austria: Computerstr. 6, A-1101 WIEN, P.O. Box 213,
Tel. +43 1 60 101 1248, Fax. +43 1 60 101 1210

Belarus: Hotel Minsk Business Center, Bld. 3, r. 1211, Volodarski Str. 6,
220050 MINSK, Tel. +375 172 20 0733, Fax. +375 172 20 0773

Belgium: see The Netherlands

Brazil: see South America

Bulgaria: Philips Bulgaria Ltd., Energoproject, 15th floor,
51 James Bourchier Blvd., 1407 SOFIA,
Tel. +359 2 68 9211, Fax. +359 2 68 9102

Canada: PHILIPS SEMICONDUCTORS/COMPONENTS,
Tel. +1 800 234 7381, Fax. +1 800 943 0087

China/Hong Kong: 501 Hong Kong Industrial Technology Centre,
72 Tat Chee Avenue, Kowloon Tong, HONG KONG,
Tel. +852 2319 7888, Fax. +852 2319 7700

Colombia: see South America

Czech Republic: see Austria

Denmark: Sydhavnsgade 23, 1780 COPENHAGEN V,
Tel. +45 33 29 3333, Fax. +45 33 29 3905

Finland: Sinikalliontie 3, FIN-02630 ESPOO,
Tel. +358 9 615 800, Fax. +358 9 6158 0920

France: 51 Rue Carnot, BP317, 92156 SURESNES Cedex,
Tel. +33 1 4099 6161, Fax. +33 1 4099 6427

Germany: Hammerbrookstraße 69, D-20097 HAMBURG,
Tel. +49 40 2353 60, Fax. +49 40 2353 6300

Hungary: see Austria

India: Philips INDIA Ltd, Band Box Building, 2nd floor,
254-D, Dr. Annie Besant Road, Worli, MUMBAI 400 025,
Tel. +91 22 493 8541, Fax. +91 22 493 0966

Indonesia: PT Philips Development Corporation, Semiconductors Division,
Gedung Philips, Jl. Buncit Raya Kav.99-100, JAKARTA 12510,
Tel. +62 21 794 0040 ext. 2501, Fax. +62 21 794 0080

Ireland: Newstead, Clonskeagh, DUBLIN 14,
Tel. +353 1 7640 000, Fax. +353 1 7640 200

Israel: RAPAC Electronics, 7 Kehilat Saloniki St, PO Box 18053,
TEL AVIV 61180, Tel. +972 3 645 0444, Fax. +972 3 649 1007

Italy: PHILIPS SEMICONDUCTORS, Piazza IV Novembre 3,
20124 MILANO, Tel. +39 02 67 52 2531, Fax. +39 02 67 52 2557

Japan: Philips Bldg 13-37, Kohnan 2-chome, Minato-ku,
TOKYO 108-8507, Tel. +81 3 3740 5130, Fax. +81 3 3740 5057

Korea: Philips House, 260-199 Itaewon-dong, Yongsan-ku, SEOUL,
Tel. +82 2 709 1412, Fax. +82 2 709 1415

Malaysia: No. 76 Jalan Universiti, 46200 PETALING JAYA, SELANGOR,
Tel. +60 3 750 5214, Fax. +60 3 757 4880

Mexico: 5900 Gateway East, Suite 200, EL PASO, TEXAS 79905,
Tel. +9-5 800 234 7381, Fax +9-5 800 943 0087

Middle East: see Italy

Netherlands: Postbus 90050, 5600 PB EINDHOVEN, Bldg. VB,
Tel. +31 40 27 82785, Fax. +31 40 27 88399

New Zealand: 2 Wagener Place, C.P.O. Box 1041, AUCKLAND,
Tel. +64 9 849 4160, Fax. +64 9 849 7811

Norway: Box 1, Manglerud 0612, OSLO,
Tel. +47 22 74 8000, Fax. +47 22 74 8341

Pakistan: see Singapore

Philippines: Philips Semiconductors Philippines Inc.,
106 Valero St. Salcedo Village, P.O. Box 2108 MCC, MAKATI,
Metro MANILA, Tel. +63 2 816 6380, Fax. +63 2 817 3474

Poland: Ul. Lukiska 10, PL 04-123 WARSZAWA,
Tel. +48 22 612 2831, Fax. +48 22 612 2327

Portugal: see Spain

Romania: see Italy

Russia: Philips Russia, Ul. Usatcheva 35A, 119048 MOSCOW,
Tel. +7 095 755 6918, Fax. +7 095 755 6919

Singapore: Lorong 1, Toa Payoh, SINGAPORE 319762,
Tel. +65 350 2538, Fax. +65 251 6500

Slovakia: see Austria

Slovenia: see Italy

South Africa: S.A. PHILIPS Pty Ltd., 195-215 Main Road Martindale,
2092 JOHANNESBURG, P.O. Box 58088 Newville 2114,
Tel. +27 11 471 5401, Fax. +27 11 471 5398

South America: Al. Vicente Pinzon, 173, 6th floor,
04547-130 SÃO PAULO, SP, Brazil,
Tel. +55 11 821 2333, Fax. +55 11 821 2382

Spain: Balmes 22, 08007 BARCELONA,
Tel. +34 93 301 6312, Fax. +34 93 301 4107

Sweden: Kottbygatan 7, Akalla, S-16485 STOCKHOLM,
Tel. +46 8 5985 2000, Fax. +46 8 5985 2745

Switzerland: Allmendstrasse 140, CH-8027 ZÜRICH,
Tel. +41 1 488 2741 Fax. +41 1 488 3263

Taiwan: Philips Semiconductors, 6F, No. 96, Chien Kuo N. Rd., Sec. 1,
TAIPEI, Taiwan Tel. +886 2 2134 2886, Fax. +886 2 2134 2874

Thailand: PHILIPS ELECTRONICS (THAILAND) Ltd.,
209/2 Sanpavuth-Bangna Road Prakanong, BANGKOK 10260,
Tel. +66 2 745 4090, Fax. +66 2 398 0793

Turkey: Yukari Dudullu, Org. San. Blg., 2.Cad. Nr. 28 81260 Umraniye,
ISTANBUL, Tel. +90 216 522 1500, Fax. +90 216 522 1813

Ukraine: PHILIPS UKRAINE, 4 Patrice Lumumba str., Building B, Floor 7,
252042 KIEV, Tel. +380 44 264 2776, Fax. +380 44 268 0461

United Kingdom: Philips Semiconductors Ltd., 276 Bath Road, Hayes,
MIDDLESEX UB3 5BX, Tel. +44 208 730 5000, Fax. +44 208 754 8421

United States: 811 East Arques Avenue, SUNNYVALE, CA 94088-3409,
Tel. +1 800 234 7381, Fax. +1 800 943 0087

Uruguay: see South America

Vietnam: see Singapore

Yugoslavia: PHILIPS, Trg N. Pasica 5/v, 11000 BEOGRAD,
Tel. +381 11 62 5344, Fax. +381 11 63 5777

For all other countries apply to: Philips Semiconductors,
International Marketing & Sales Communications, Building BE-p, P.O. Box 218,
5600 MD EINDHOVEN, The Netherlands, Fax. +31 40 27 24825

Internet: <http://www.semiconductors.philips.com>

© Philips Electronics N.V. 1999

SCA 66

All rights are reserved. Reproduction in whole or in part is prohibited without the prior written consent of the copyright owner.

The information presented in this document does not form part of any quotation or contract, is believed to be accurate and reliable and may be changed without notice. No liability will be accepted by the publisher for any consequence of its use. Publication thereof does not convey nor imply any license under patent- or other industrial or intellectual property rights.

Printed in The Netherlands

125002/05/pp12

Date of release: 1999 Jun 25

Document order number: 9397 750 05708

Let's make things better.

**Philips
Semiconductors**



PHILIPS